

MATERIAL SPECIFICATION

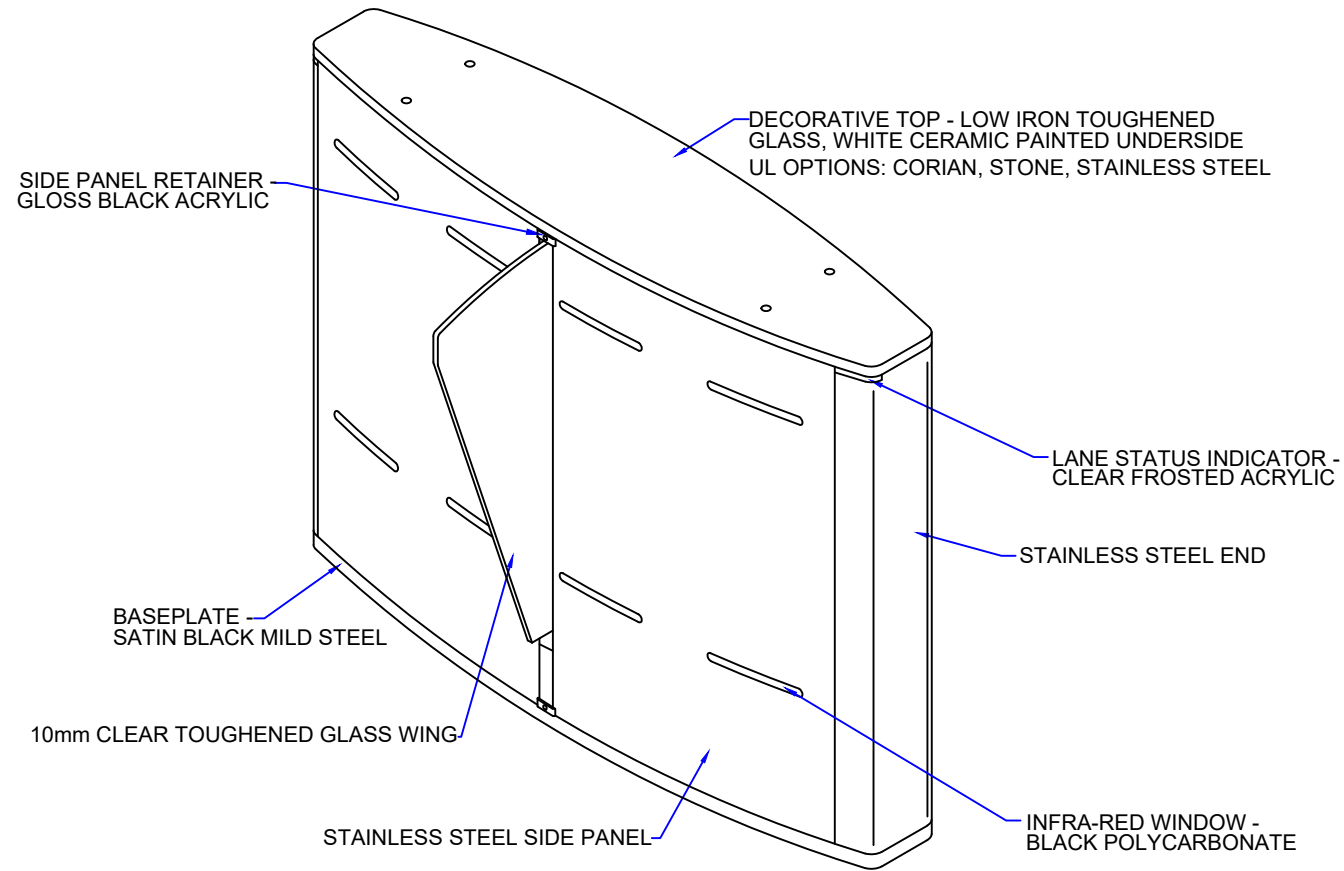

ALL GLASS IS TOUGHENED - EN12150 / ANSI Z97.1
 ALL STAINLESS STEEL IS 304, 240 GRIT (SATIN No. 4), HORIZONTAL GRAIN

LANE LAYOUT & GENERAL DIMENSIONS

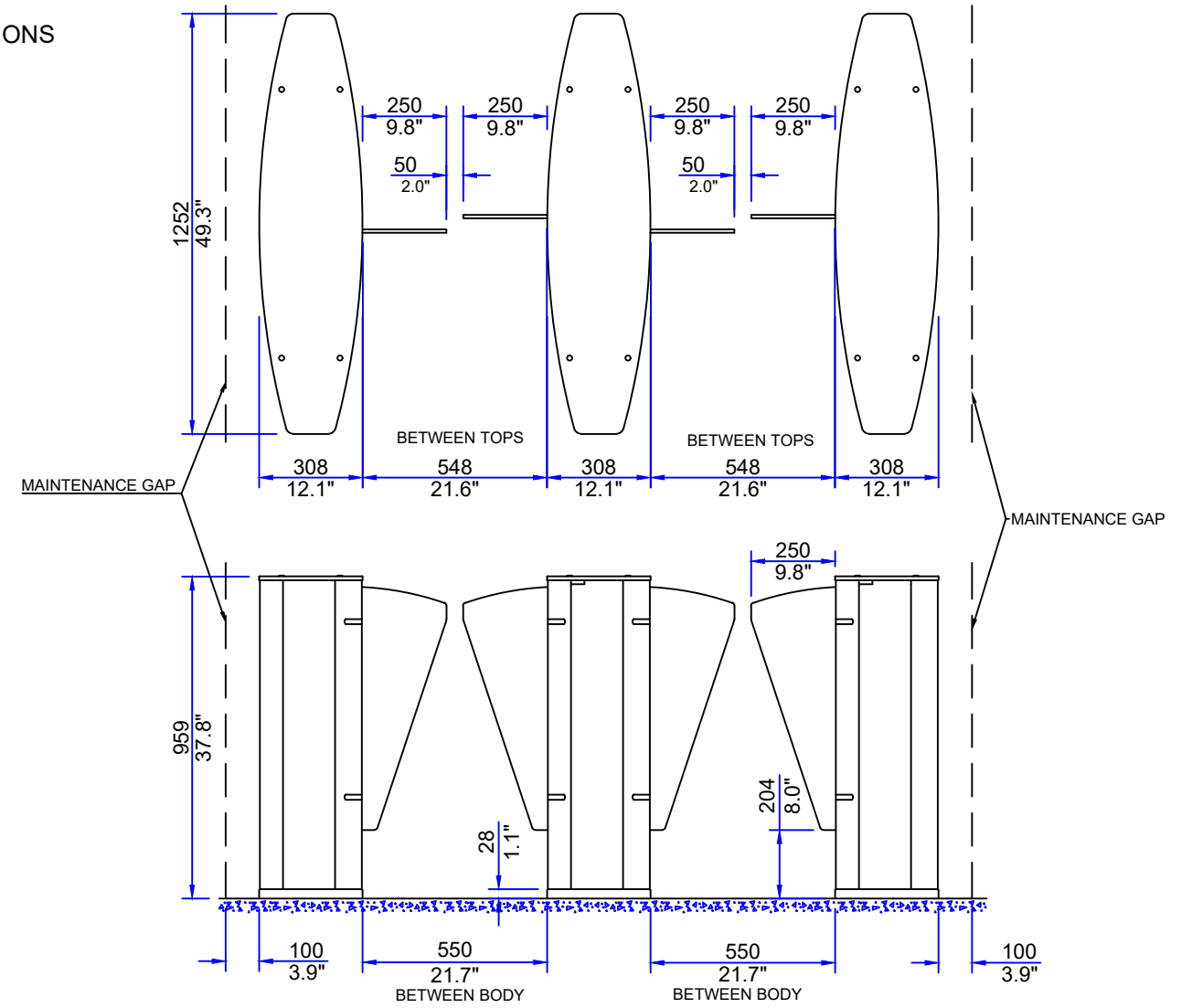

READER MOUNTING OPTIONS

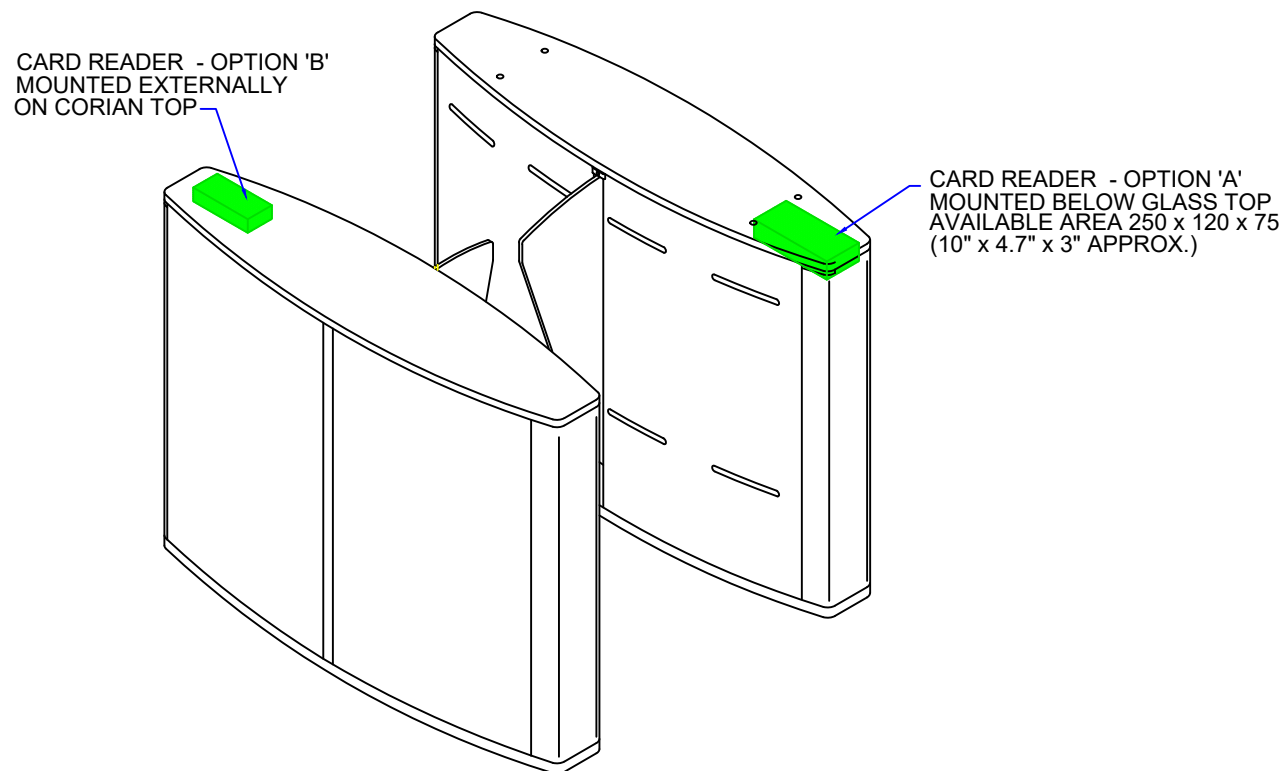

PEDESTAL FOOTPRINT

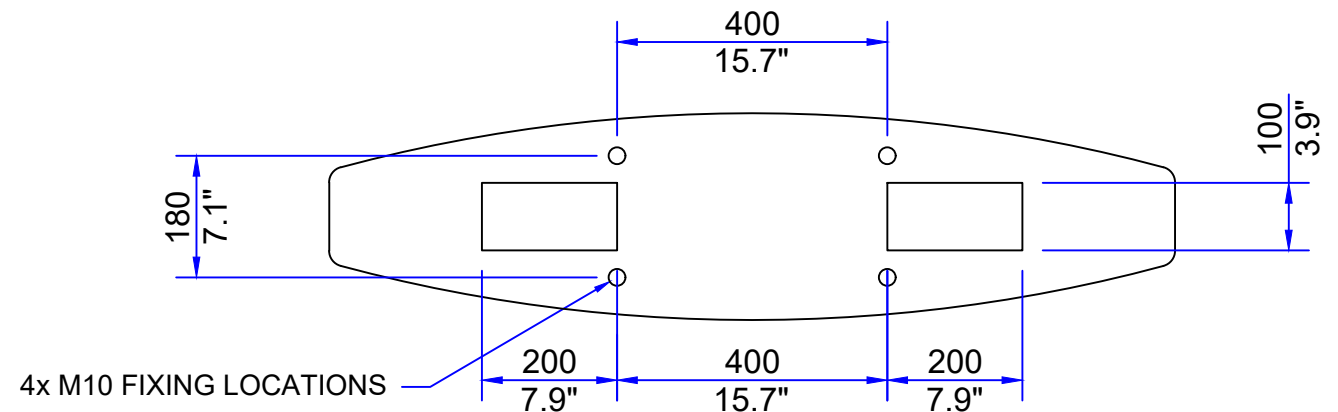

PRODUCT: GLASSWING COMPACT

TITLE: GENERAL INFORMATION

DRAWING No: GWCPTS_A5

FOR SALES INFORMATION ONLY-SUBJECT TO CHANGE
 ALL DIMENSIONS +/-2mm

This document is the copyright of Integrated Design LTD

