

MATERIAL SPECIFICATIONS

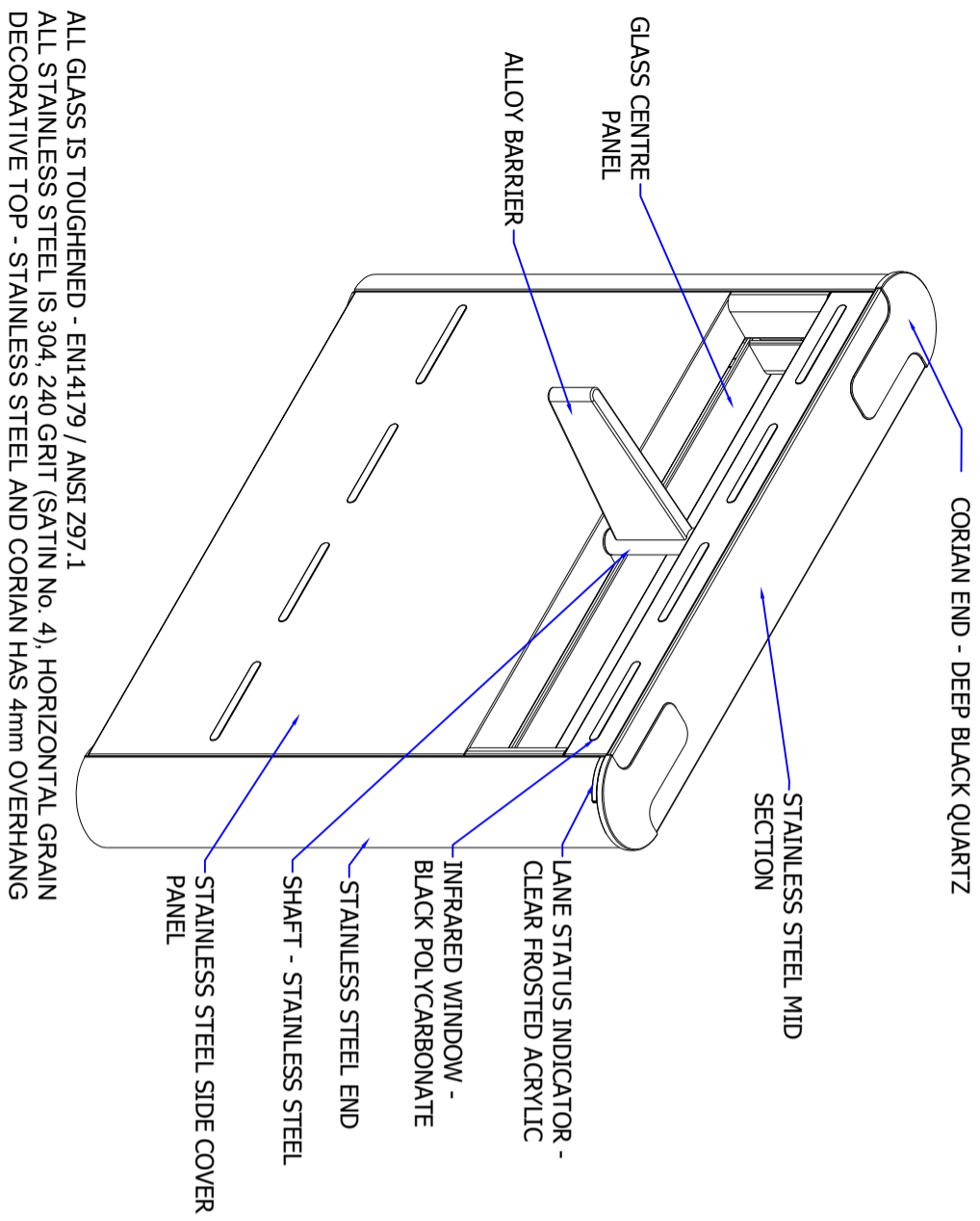

READER MOUNTING OPTIONS

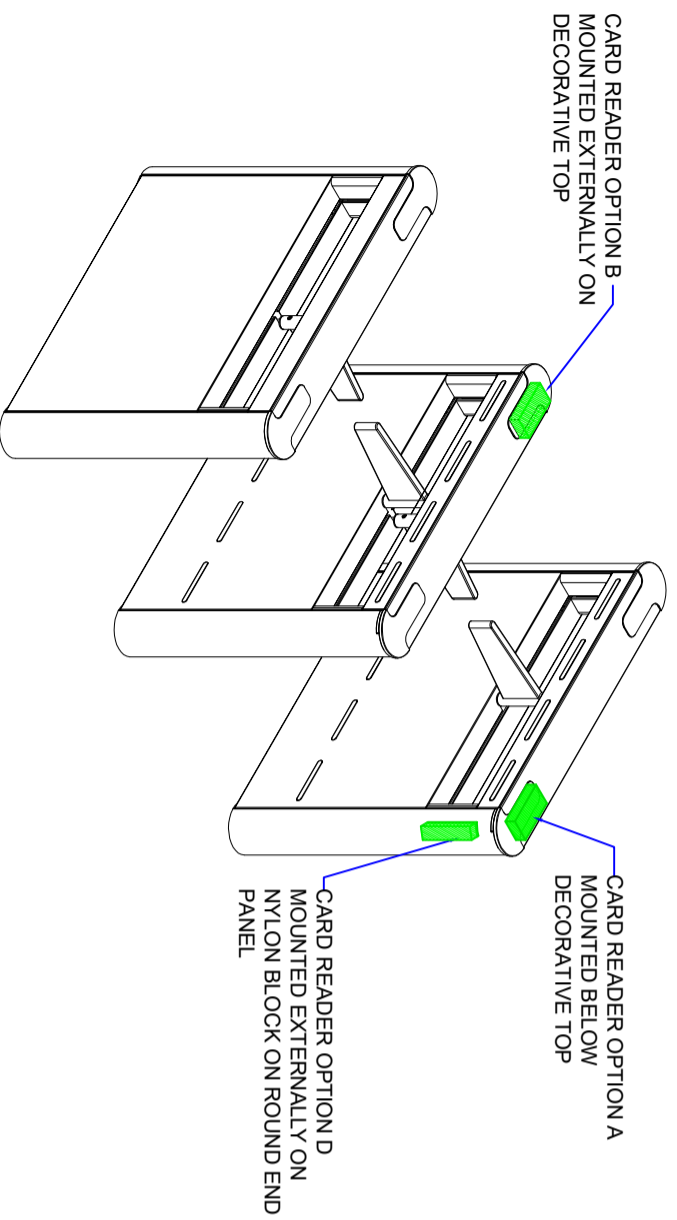

LANE LAYOUT & GENERAL DIMENSIONS

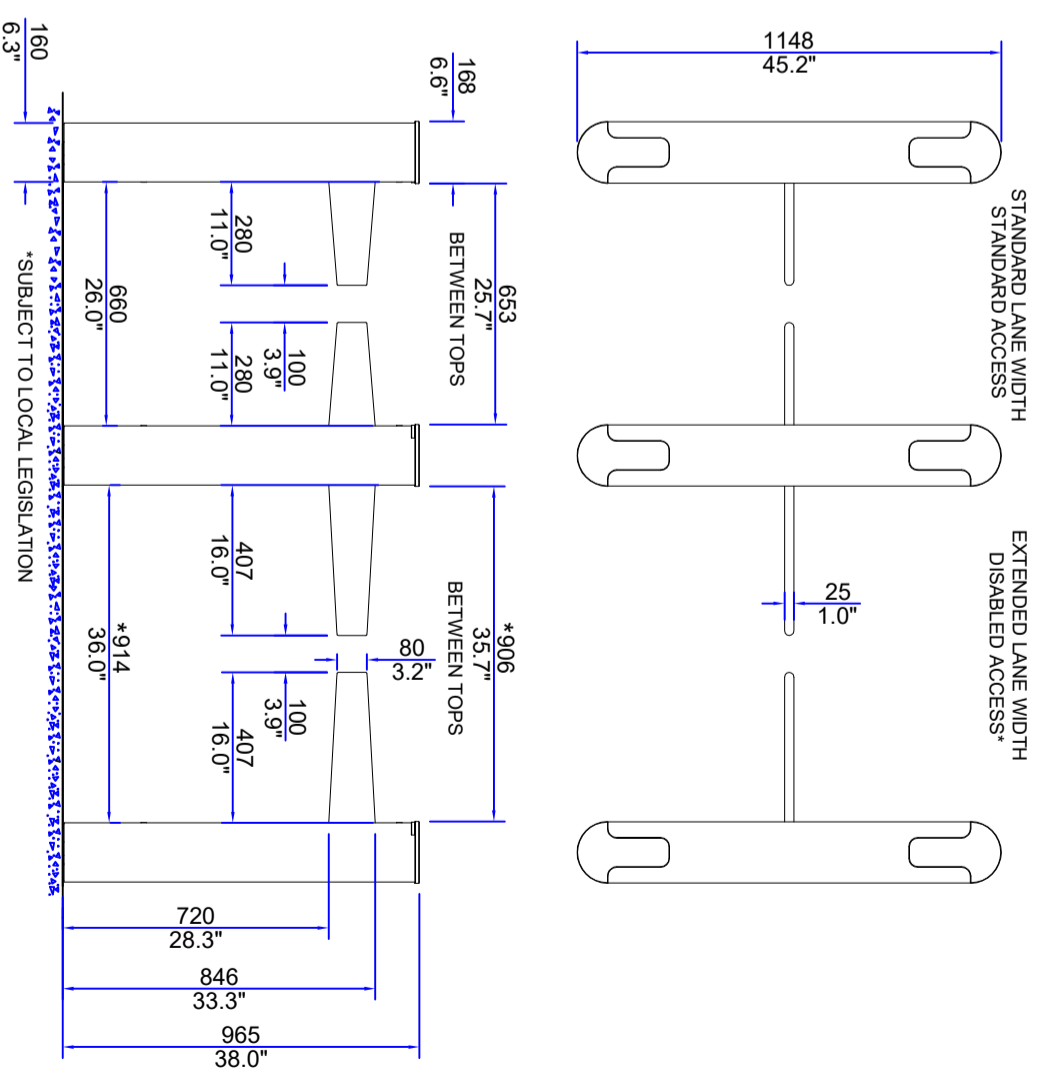

PEDESTAL FOOTPRINT

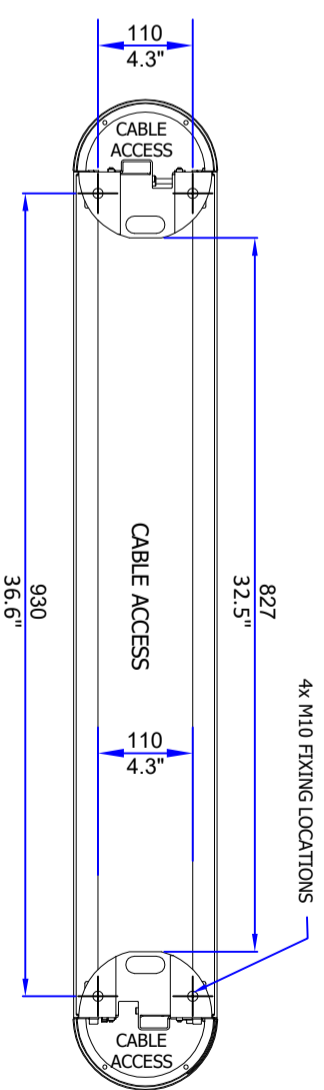

PRODUCT: FASTLANE PLUS 150SA
TITLE: GENERAL INFORMATION

DRAWING No: FP150SA_A1

FOR SALES INFORMATION ONLY-SUBJECT TO CHANGE
 ALL DIMENSIONS +/- 2MM

This document is the copyright of Integrated Design Ltd



fastlane