

MATERIAL SPECIFICATIONS

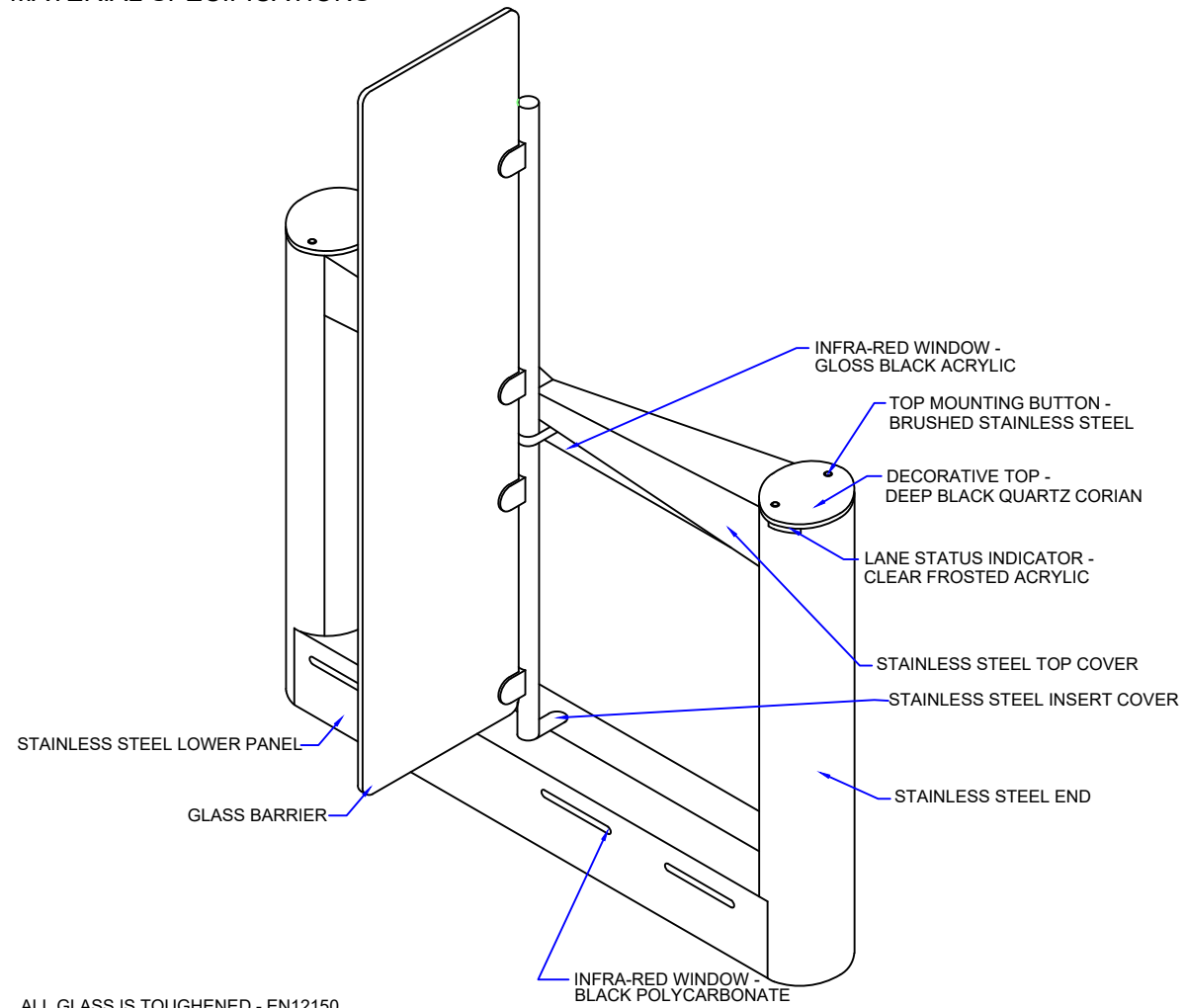

ALL GLASS IS TOUGHENED - EN12150
 ALL STAINLESS STEEL IS 304, 240 GRIT (SATIN No. 4), HORIZONTAL GRAIN
 DECORATIVE TOP - STAINLESS STEEL AND CORIAN HAS 4mm OVERHANG

LANE LAYOUT & GENERAL DIMENSIONS

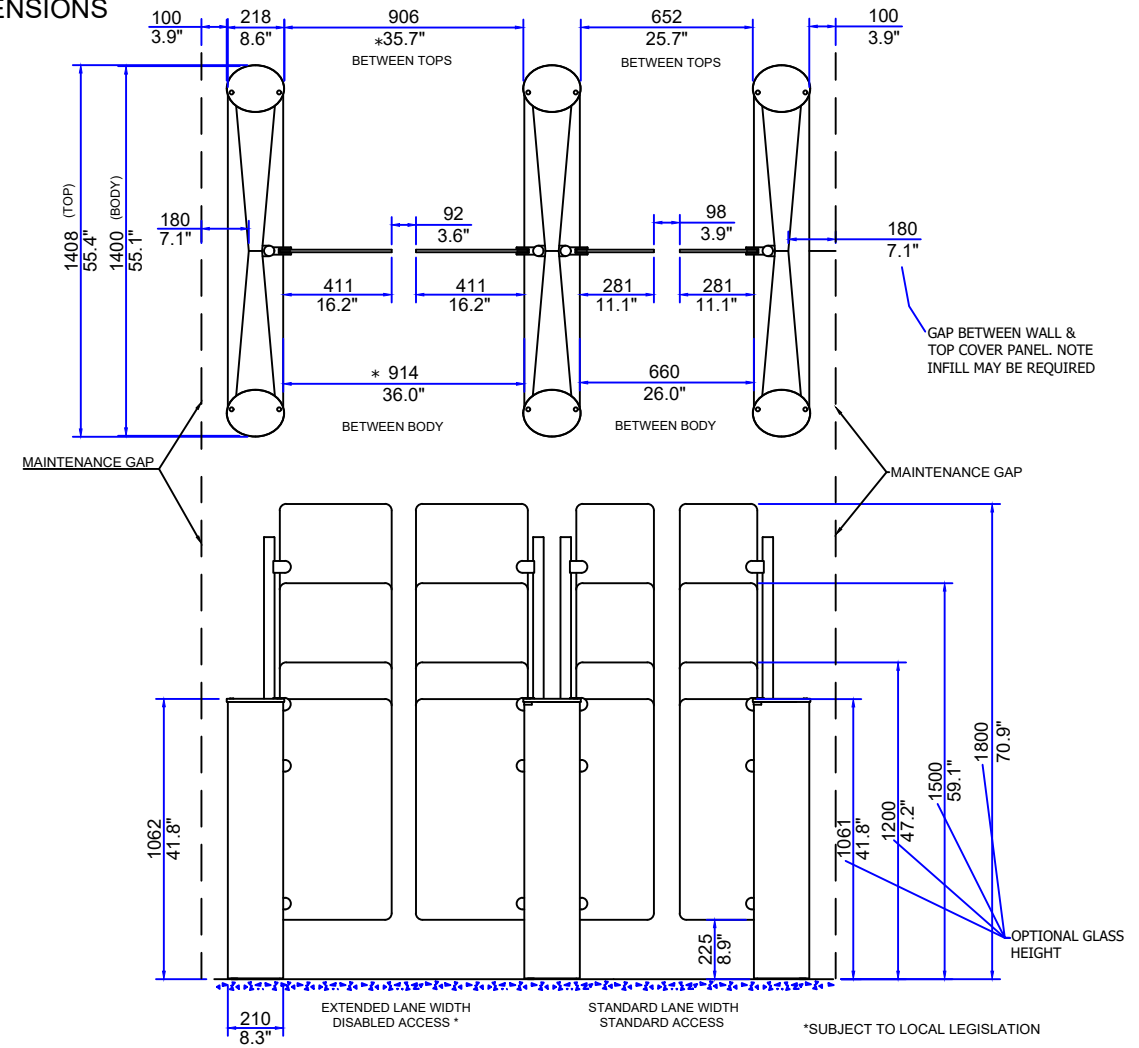

READER MOUNTING OPTIONS

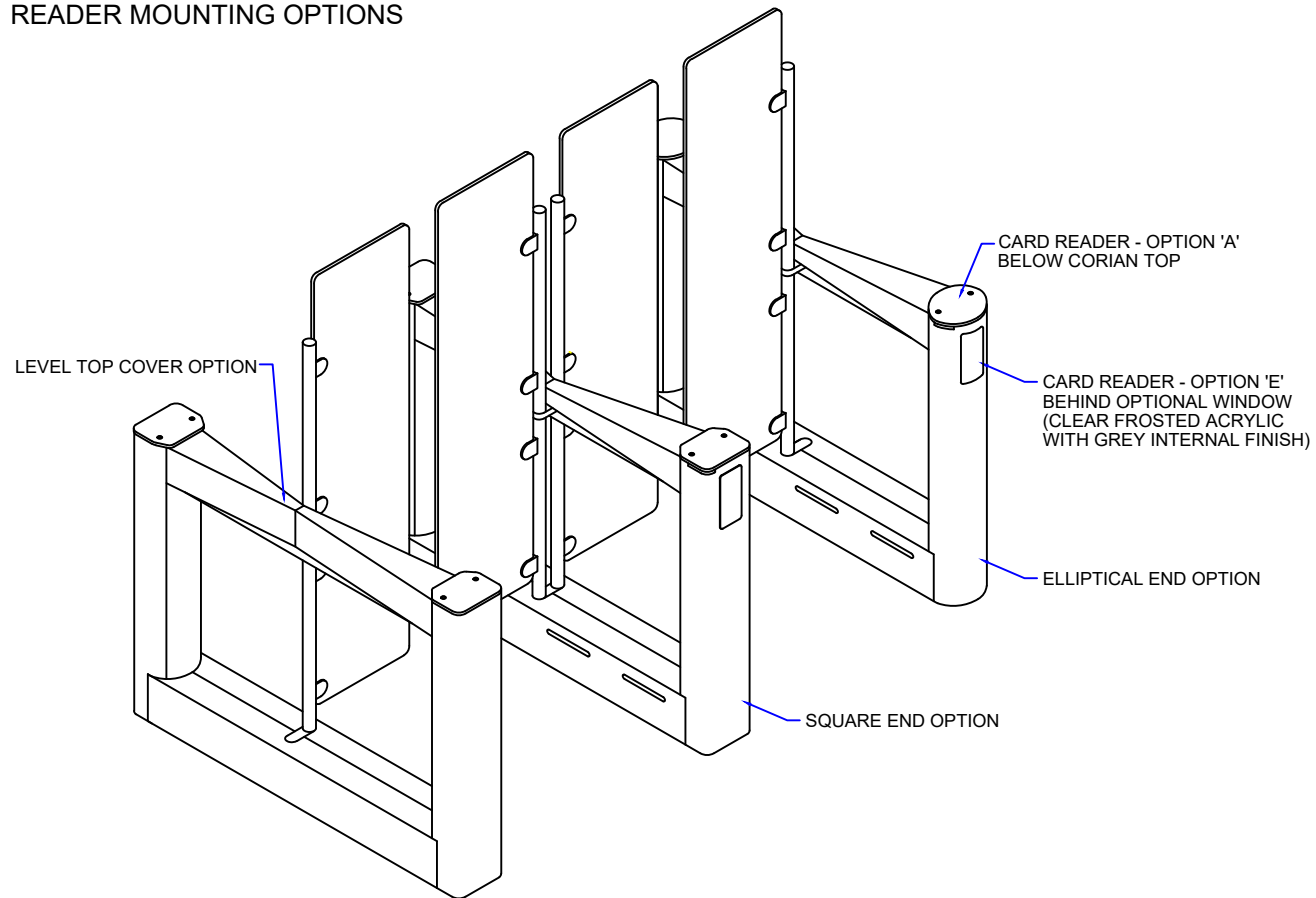

PEDESTAL FOOTPRINT

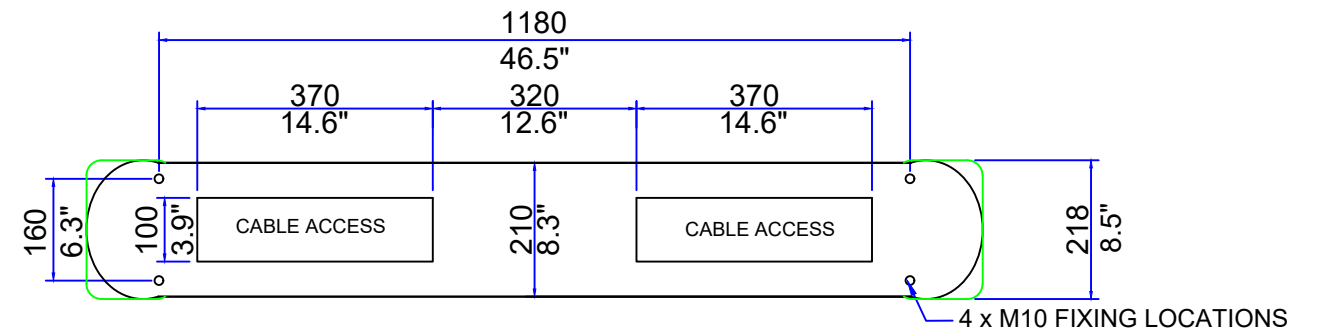

PRODUCT: GLASSGATE 400

TITLE: GENERAL INFORMATION

DRAWING No: GG400_A8

FOR SALES INFORMATION ONLY-SUBJECT TO CHANGE
 ALL DIMENSIONS +/-2mm

This document is the copyright of Integrated Design LTD

