

MATERIAL SPECIFICATIONS

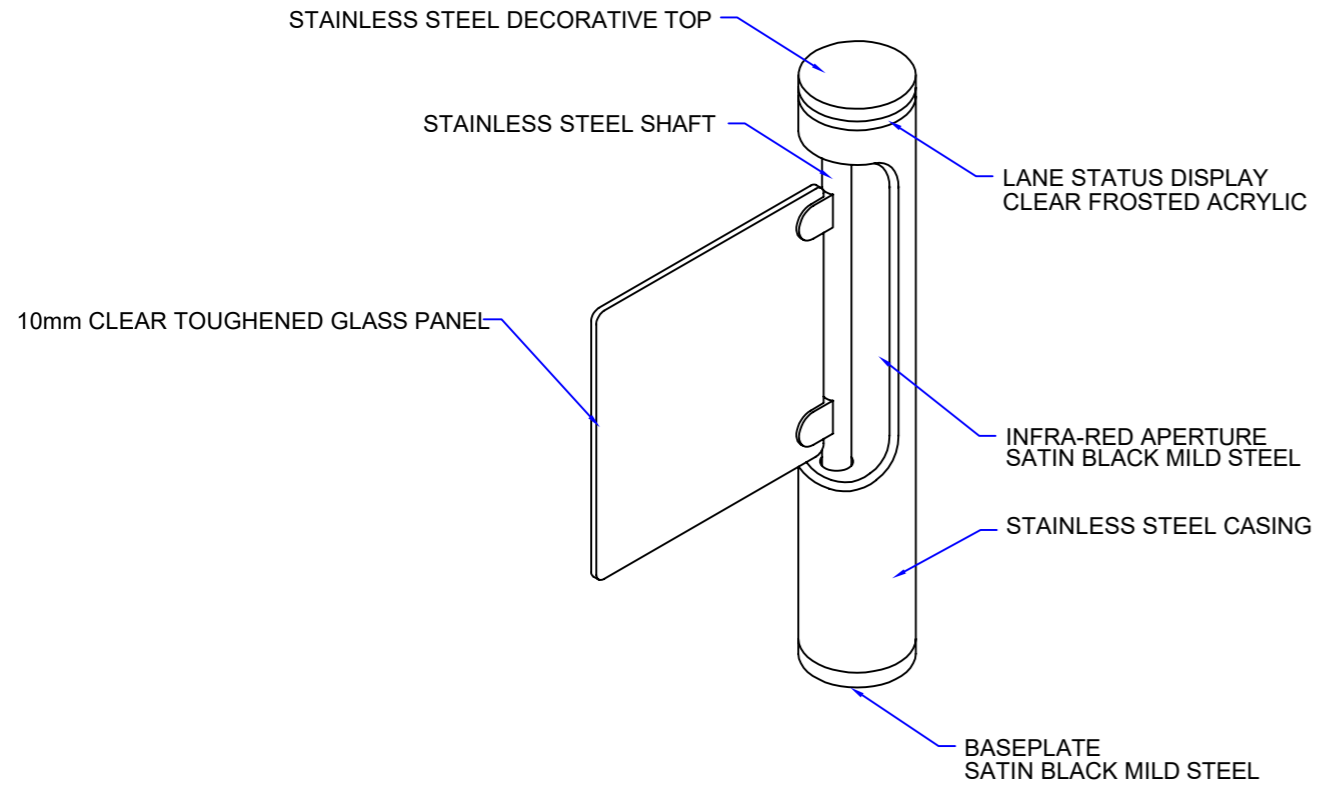

ALL GLASS IS TOUGHENED - EN14179
ALL STAINLESS STEEL IS 304, 240 GRIT (SATIN No. 4), HORIZONTAL GRAIN

LANE LAYOUT & GENERAL DIMENSIONS

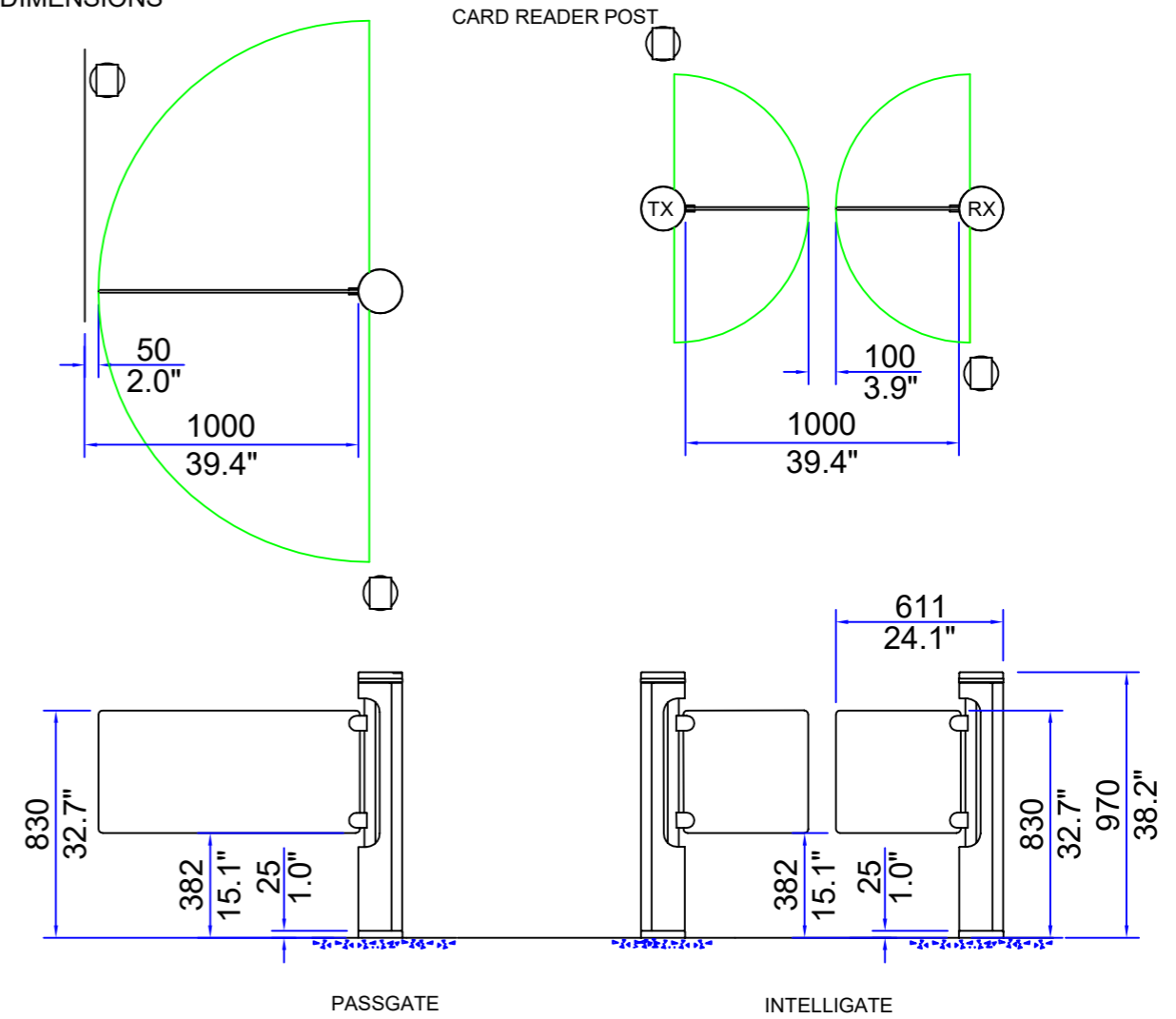

READER DETAILS

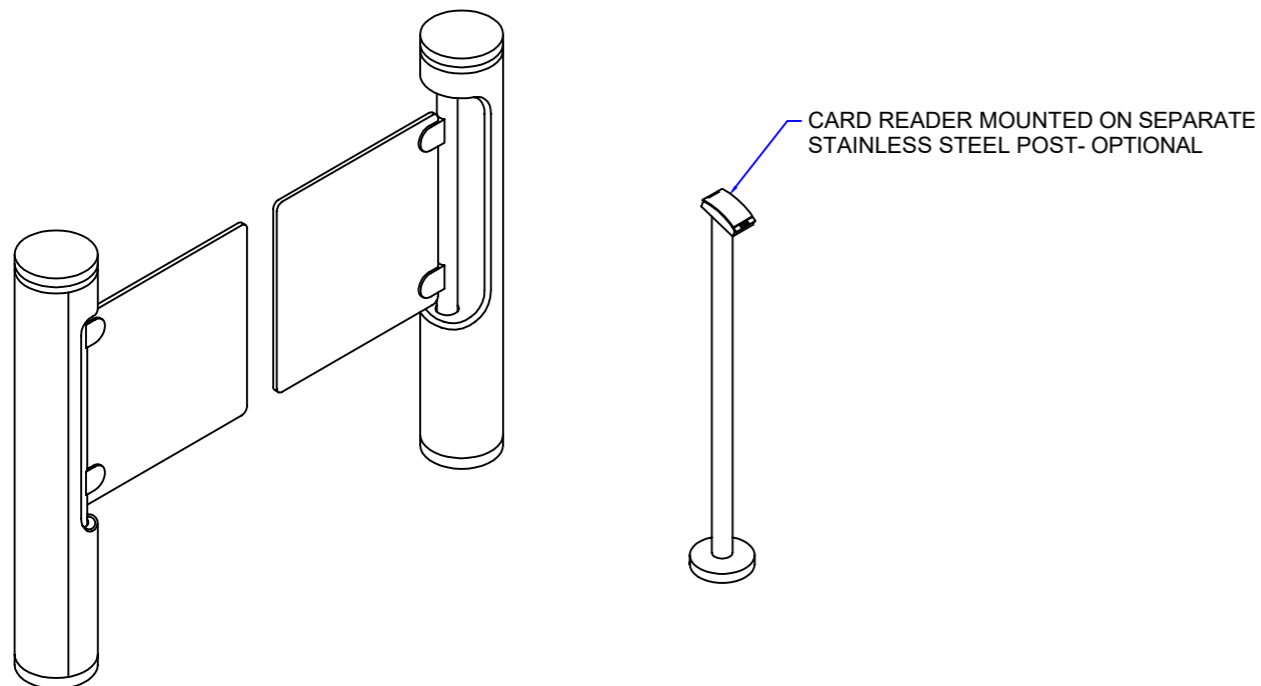

PEDESTAL FOOTPRINT

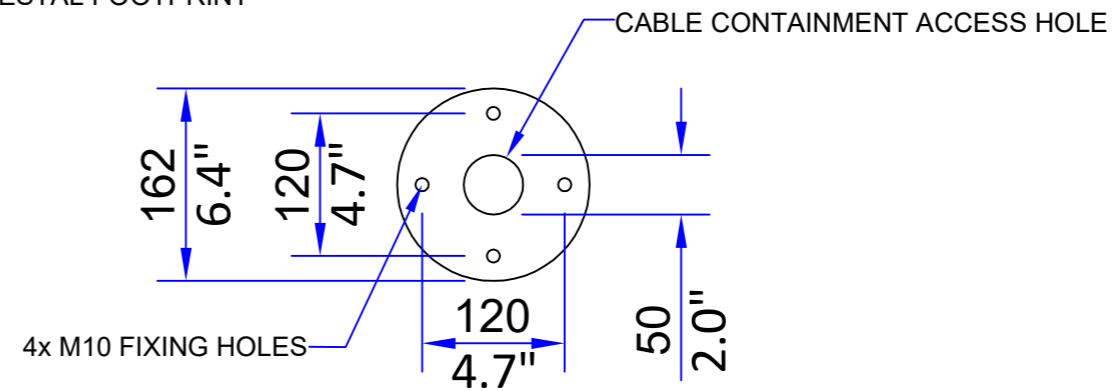

PRODUCT: INTELLIGATE/PASSGATE

TITLE: GENERAL INFORMATION

DRAWING No: INTELLIG_A4

FOR SALES INFORMATION ONLY- SUBJECT TO CHANGE
ALL DIMENSIONS +/-2mm

This document is the copyright of Integrated Design LTD

