

MATERIAL SPECIFICATIONS

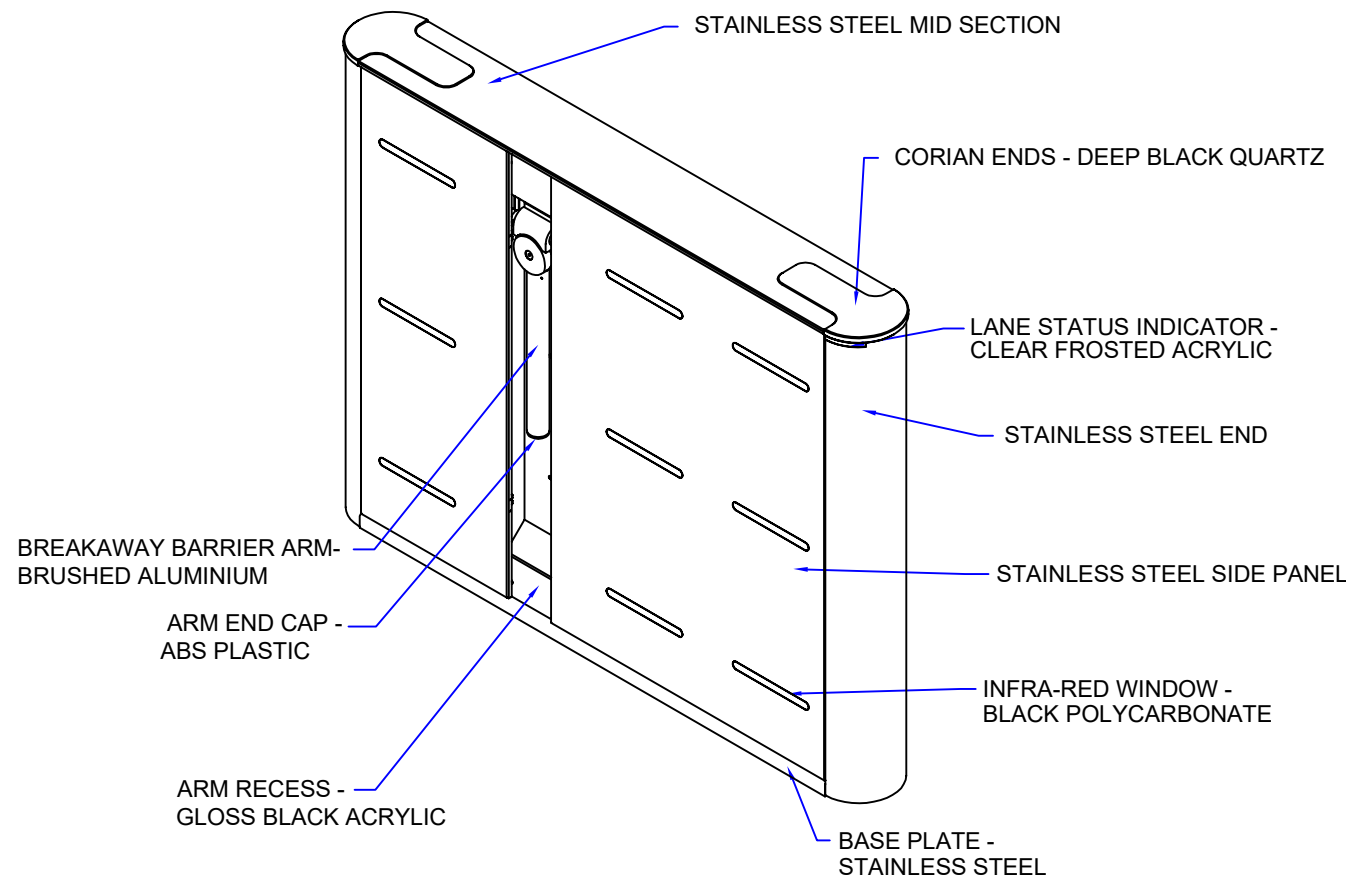

ALL STAINLESS STEEL IS 304, 240 GRIT (SATIN No. 4), HORIZONTAL GRAIN
 DECORATIVE TOP - STAINLESS STEEL AND CORIAN HAS 4mm OVERHANG

LANE LAYOUT & GENERAL DIMENSIONS

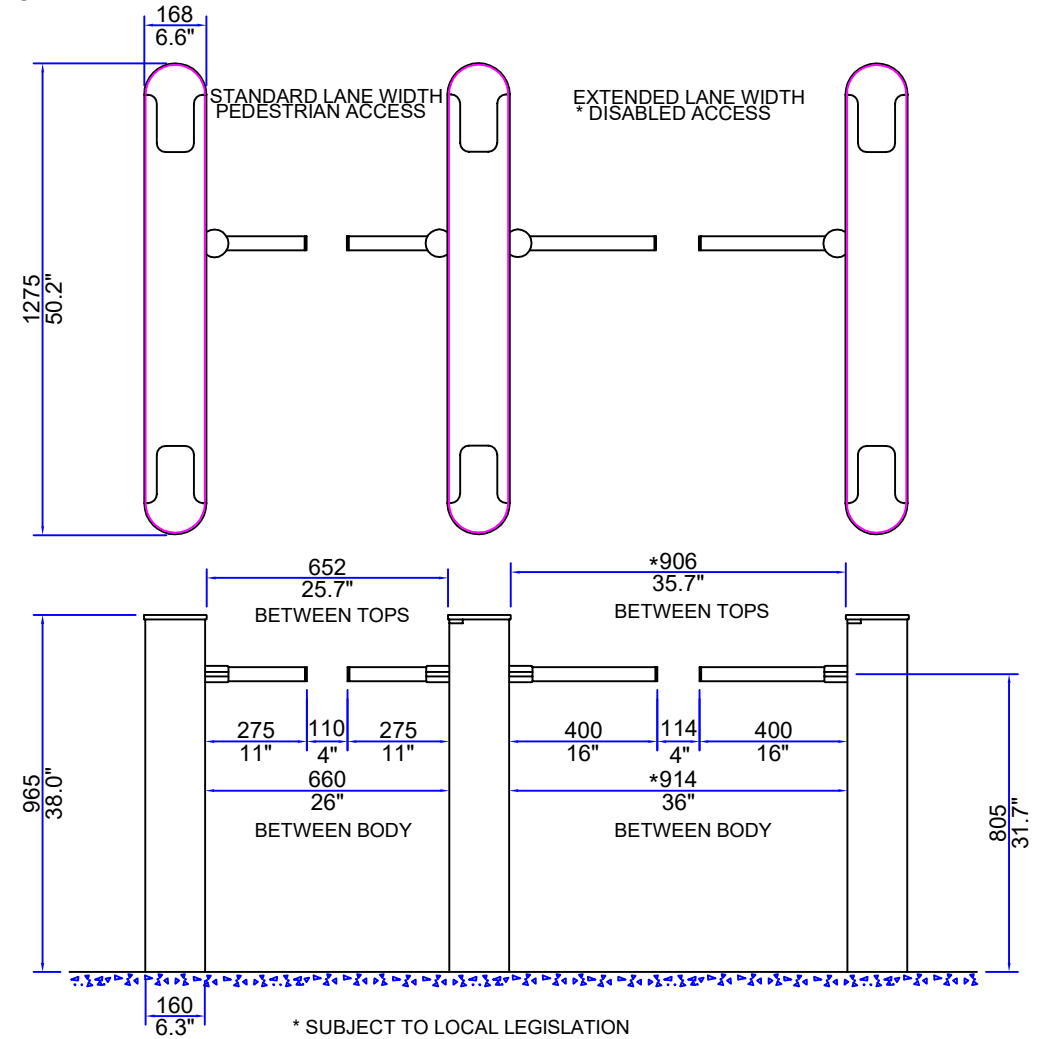

READER MOUNTING OPTIONS

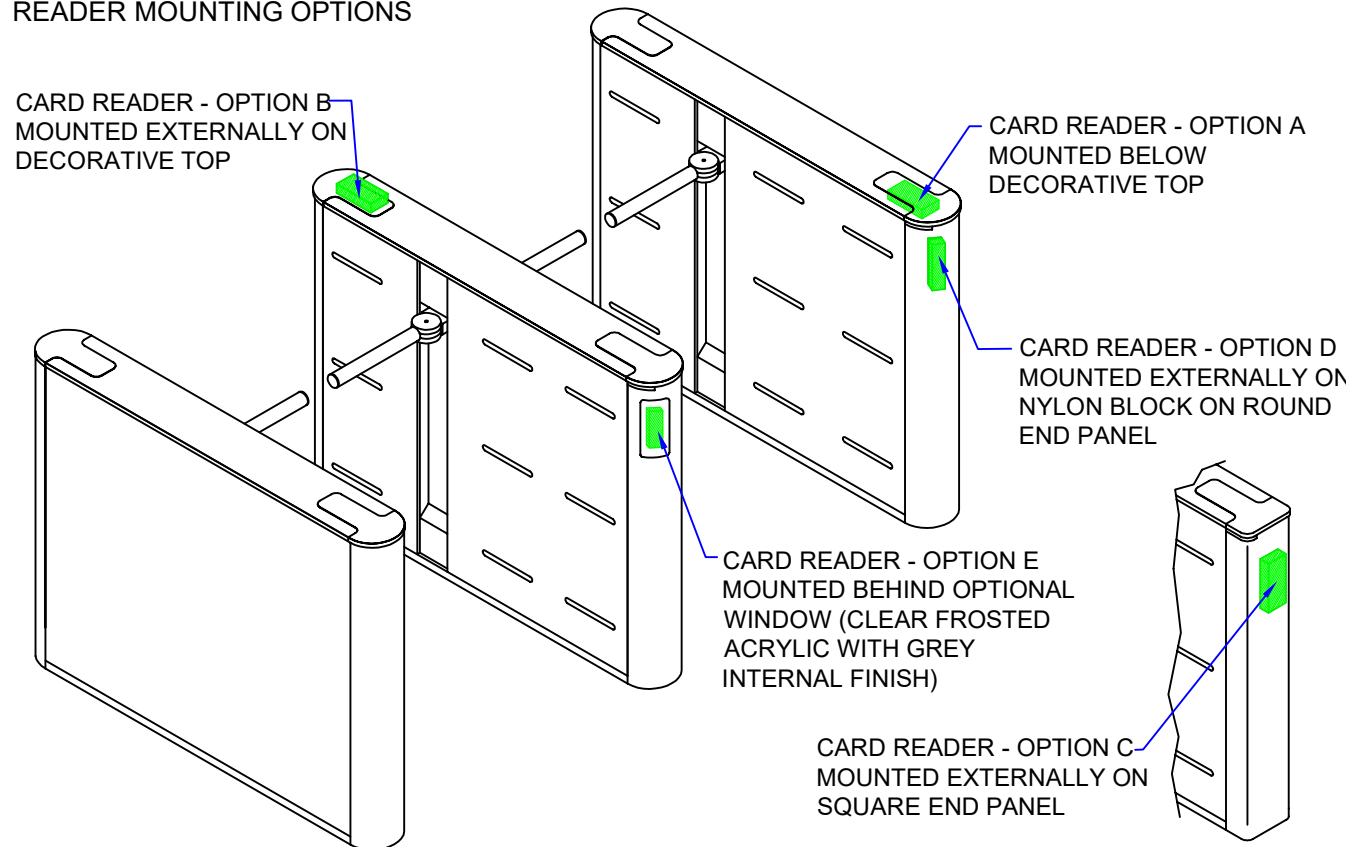

PEDESTAL FOOTPRINT

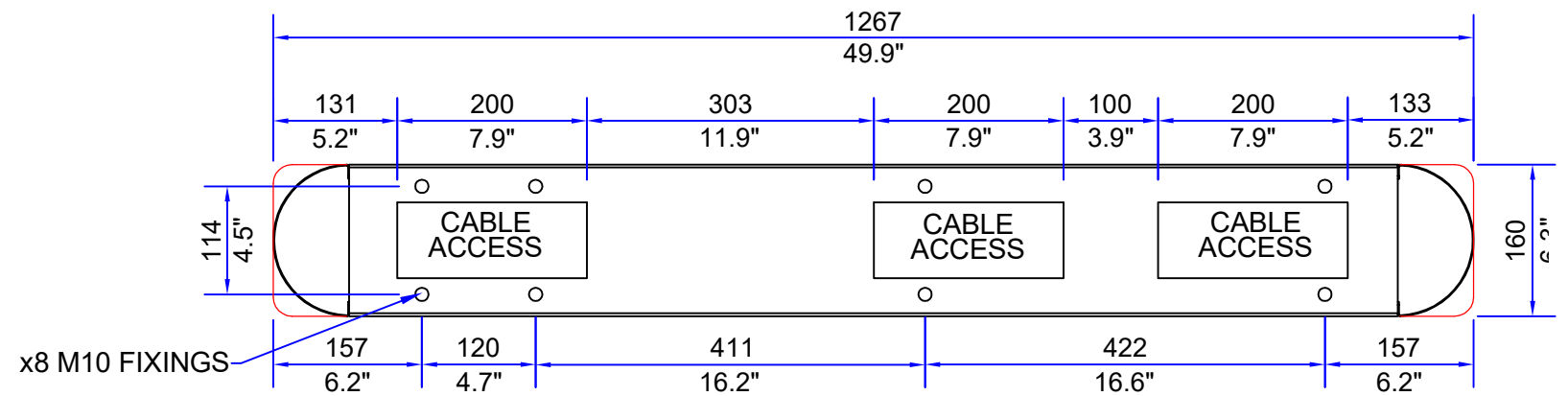

PRODUCT: FASTLANE PLUS 400 AS

TITLE: GENERAL INFORMATION

DRAWING No: FP400AS_A2

FOR SALES INFORMATION ONLY -SUBJECT TO CHANGE
 ALL DIMENSIONS +/-2mm

This document is the copyright of Integrated Design LTD

